

Depth Illuminant LED Inground Light AXIS

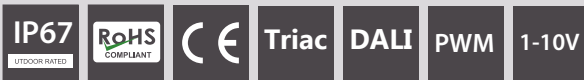

Hard chromeplated Stainless steel SUS 316L
12# Die-casting grey powder coated aluminum.
T=60-80µm Adhesion of ISO class 1/ASTM class 4B

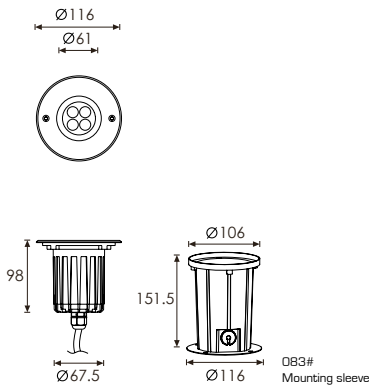

334 156	LED Power	Colour Temp	Luminous
24V - 6,5W	2000K	600 lm	
120/240V - 7,5W	3000K	488 lm	
	6000K		

LIGHT DISTRIBUTION

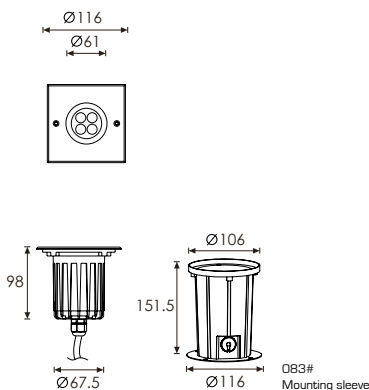
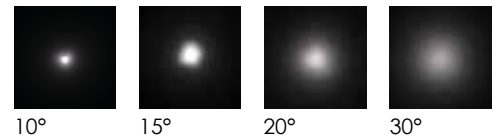
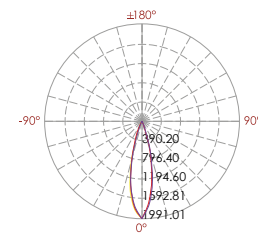

334 157	LED Power	Colour Temp	Luminous
24V - 6,5W	2000K	600 lm	
120/240V - 7,5W	3000K	488 lm	
	6000K		

LIGHT DISTRIBUTION

